

DELMAR LINEAR DRAIN STANDARD LENGTH

Kit Includes:

- A** Lifting Key
- B** Grate
- C** Hair/Debris Strainer
- D** Base
- E** Leveling Legs
- F** Threaded nipple

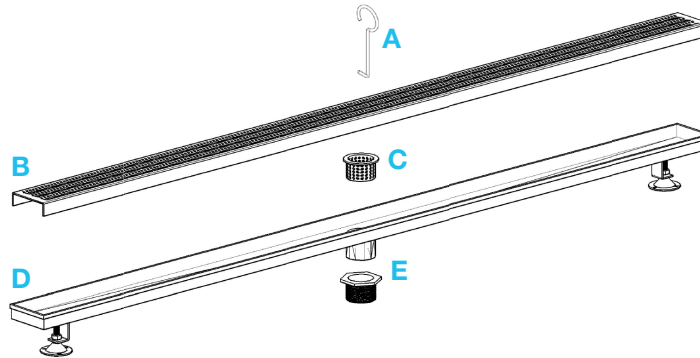

Specifications

B Grate - Top View
Nami - Kai

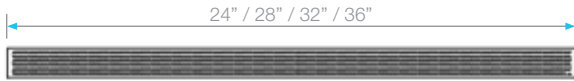

Mist



Delta - Wedgewire



Side View
Nami - Kai - Delta



Mist

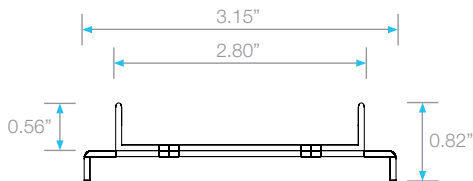

E Base - Side View

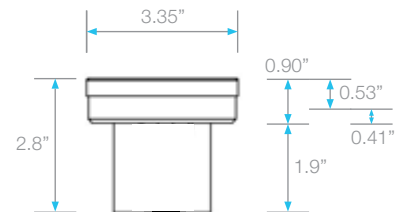

Top View
Nami - Kai

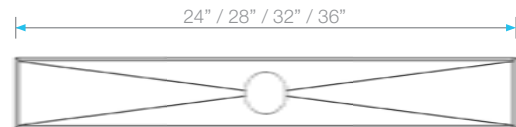

Delta - Mist - Wedgewire

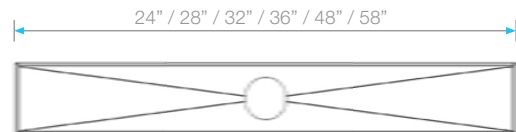

Side View

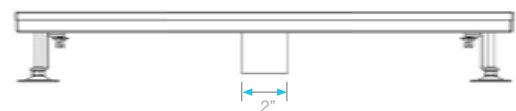

Delmar Series Features

- 16 gauge 316 Stainless Steel Grate = 1.5 mm.
- 18 gauge 316 Stainless Steel Base = 1.2 mm.
- Works with 2" ABS, PVC or Cast Iron shower drain flange (not included).
- Delmar Series is intended for use with traditional waterproofing methods.
- Hair Strainer Basket comes with every drain, fits inside the drain to collect hair and other debris, preventing pipe clogs.
- Standard Finishes: Satin, Polished, ORB/Black, Bronze, and Satin Gold.
- Grate can be removed completely for cleaning.

Complete Kit

Lotus	Length	Bronze SKU	ORB/Black SKU	Satin Gold SKU
	24"	33.700.02	33.700.02 ORB	33.700.02 G
	28"	33.700.03	33.700.03 ORB	33.700.02 G
	32"	33.700.04	33.700.04 ORB	33.700.02 G
	36"	33.700.05	33.700.05 ORB	33.700.02 G
	48"	33.700.06	33.700.06 ORB	33.700.02 G
	58"	33.700.07	33.700.07 ORB	33.700.02 G

Wedgwire	Length	Satin SKU	Polished SKU	Mist (Tile-in)	Length	Satin SKU	ORB/Black SKU
	24"	33.700.02	33.700.02 P		24"	33.500.02	33.500.02 ORB
	28"	33.700.03	33.700.03 P		28"	33.500.03	33.500.03 ORB
	32"	33.700.04	33.700.04 P		32"	33.500.04	33.500.04 ORB
	36"	33.700.05	33.700.05 P		36"	33.500.05	33.500.05 ORB
	48"	33.700.06	33.700.06 P		48"	33.500.06	33.500.06 ORB
	58"	33.700.07	33.700.07 P		58"	33.500.07	33.500.07 ORB

Delta	Length	Satin SKU	Polished SKU	Kai	Length	SKU
	24"	33.300.02	33.300.02 P		24"	33.200.02
	28"	33.300.03	33.300.03 P		28"	33.200.03
	32"	33.300.04	33.300.04 P		32"	33.200.04
	36"	33.300.05	33.300.05 P		36"	33.700.05
	48"	33.300.06	33.300.06 P		24"	33.100.02
	58"	33.300.07	33.300.07 P		28"	33.100.03
					32"	33.100.04
					36"	33.100.05

Kit includes

- Lifting Key
- Grate
- Hair/Debris Strainer
- Base
- Leveling Legs
- Threaded Nipple/Adapter

Add to Kit



Drain Flange	SKU
2" PVC	83.100.00 PVC
2" ABS	83.100.00 ABS
2" Cast Iron No hub	83.100.01
2" Cast Iron FIP	83.100.01F

Note: Installer must verify all rough-in dimensions prior to installation and consult local and national codes. Conformity and compliance to local and national codes are the responsibility of the installer. Dimensions are subject to Manufacturers tolerance and change without notice. We can assume no responsibility for use of superseded or void data.